

THE



CORE

FOUR

WRENCHES

SOCKETS

RATCHETS

ATTACHMENTS

Since 1927, we've been manufacturing the industry's leading hand tools featuring the highest quality and most innovative technology. The products shown here are our four top-selling categories. They are the core of our full line of professional tools.



WRIGHT 

FORGING WRENCHES.

FORGING RATCHETS.

FORGING SOCKETS.

FORGING ATTACHMENTS.

FORGING RESPECT™.

WRIGHT 

FOR ALMOST 100 YEARS WE'VE BEEN INNOVATING, ENGINEERING, AND FORGING TOOLS THAT EXCEED WHERE OTHERS FAIL.

At Wright, our vision has always been to ensure confidence and protect those that are building our tomorrow. And when we do that, we're forging more than just tools. We're forging partnerships. We're forging respect. Something we don't intend to lose anytime soon.

AMERICAN MADE QUALITY.

Since 1927, the Wright Tool Company has manufactured the highest quality hand tools in the industry. No exceptions. Upon striking the first forging here in Ohio, our tools have been engineered and crafted by hardworking Americans, for hardworking Americans. We have no intentions on slowing down either—Wright has continued to innovate when everyone else says "good enough"—and we have the patents to prove it. All of these are reasons why our tools aren't inexpensive, because frankly, you get what you pay for. We forge tools for those who understand value isn't represented by a price tag, but rather downtime and replacement.

Professionals working in the world's harshest environments demand performance and safety that exceeds the standard, because failure is not an option. This is why we only use the best—Wright alloy steel. The use of our proprietary steel, precision heat treating, and advanced manufacturing techniques results in products of long life, durability and toughness. The end result are products built to exceed industry standards, because good enough is never good enough.

We finish that American innovation and hard work off with an equally hardworking lifetime warranty—one that you'll likely never need.



WE CONFIDENTLY BACK OUR TOOLS WITH A LIFETIME WARRANTY

Therefore for as long as you own it, any product manufactured by Wright Tool which fails to render service due to defect in workmanship or materials will be replaced at no charge.

Wright Tool does not provide any warranty for products labeled other than Wright Tool or Cougar Pro. This limited lifetime warranty replacement does not apply to any defects caused in whole or in part by improper use, accident, abuse, alteration, and neglect or normal wear from use. Wright Tool makes no other warranties, express or implied, with respect to the tools or their suitability for specific applications. Wright Tool neither assumes, nor authorizes any person to assume, any other warranty or obligation express or implied. Please contact your Wright distributor for additional information on our warranty policy and process for replacement. You can also call 800.321.2902 to speak with Wright Customer Service.

TOUGH TOOLS MADE FOR TOUGH WORK

Commercial Construction

Government GSA

Heavy Equipment &
Machinery

Industrial MRO

Infrastructure

Mining

Oil & Gas

Power Generation

Solar Energy

Wind Energy



WHEN YOU'VE BEEN FORGING FOR THIS
LONG, YOU LEARN A LOT. THE MOST
IMPORTANT? DON'T PUT YOUR NAME
ON SOMETHING THAT ISN'T THE BEST.

WRIGHT.



THE LAST PRIVATELY HELD, ALL-AMERICAN- MADE TOOL MANUFACTURER IN THE US MARKET.

Wright provides industrial-grade, premium-quality wrenches, ratchets, sockets and attachments to the professional users who make their living using their tools in the industrial, contractor and MRO markets. All of Wright tools are sold through independent distribution along with some key national accounts, but these days we are looking to speak less to the distributor and more to the end user. When the end-user starts demanding Wright quality, the distributors will be happy to provide it. All Wright manufactured products are made in the U.S.A. and carry lifetime guarantees against defects in workmanship.

WRENCHES

Wright wrenches feel as good as they look have a reserve of strength for tough jobs. They feature the patented Wright Drive® and WrightGrip™, which provides more torque with less fastener damage.

- Satin and full polish Sets
- Adjustable Wrenches
- Striking Wrenches
- Size Ranges: 5/32" to 4" SAE and 4mm to 80mm Metric

TORQUE PRODUCTS

Designed for precision tightening in crucial applications, Wright torque wrenches are available in three styles: micro adjustable, dial and electric dial. Other torque products include torque screwdrivers, torque multipliers and a torque tester.

- Accuracy of + - 4% in the clockwise direction
- Calibration traceable to NIST
- Scale in English and metric
- Drive ranges: 1/4" to 1"

SOCKETS, RATCHETS AND ATTACHMENTS

All Wright sockets feature the patented Wright Drive® for more torque and less fastener damage. We offer single-pawl and double-pawl ratchets, as well as attachments ranging from extensions and spinners to universals and flex handles.

- SAE and Metric, 6-point and 12-point Wright Drive®
- Hex Bit Sockets
- Sets
- Handles and Attachments
- 1/4" Drive through 3-1/2" Drive

IMPACT SOCKETS

Our impact sockets are built stronger and tougher to withstand repeated loads from impact guns. They also feature a black finish to prevent chipping.

- Wright Drive®
- SAE and Metric
- Impact Attachments
- Drive Ranges: 3/8" to 3-1/2"
- Size Ranges: 5/16" to 10-1/4" SAE and 6mm to 225mm metric

WRIGHT GRIP™ 2.0

THE WRENCH THEY WERE AFRAID YOU'D FIND

Our advanced opening profile places more metal in high-stress areas to stiffen the jaws, increase tool strength and reduce permanent jaw spread—now a standard feature on the Wright open-end of combination wrenches. Precision placed protrusions are custom engineered for each wrench size to keep it seated on the fastener, increase torque and reduce slippage. Simply put, you won't find a better wrench. Period.

NOTICEABLE PERFORMANCE

50%

More protrusion
engagement than
all wrenches

80%

Stronger than all
wrenches

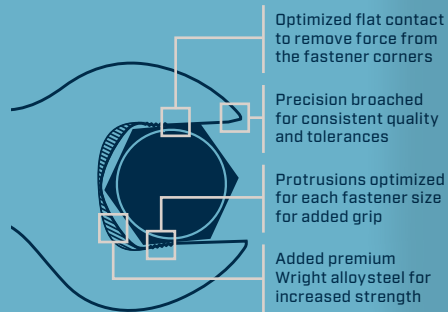

WRIGHTDRIVE.

WE STRESSED THE DETAILS, SO YOU DON'T STRESS THE CORNERS.

The Wright Drive design distributes contact stress more effectively than any other wrench system available. It spreads stress evenly over a larger contact area and away from the fastener corners.

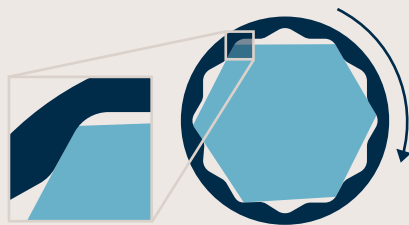

WRIGHT DRIVE® 12-POINT

The Wright Drive 12-point has up to ten times more tool-to-fastener contact area than conventional 12-point wrenches. This design improves fastener torque load while decreasing rounding and distortion of the fastener.

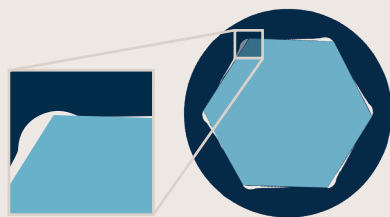

WRIGHT DRIVE® 6-POINT

The Wright Drive 6-point moves the contact area away from the corners, creating greater strength, more torque. Its circle diameter reduces fastener rounding and allows better grip on undersized fasteners and previously rounded corners.

NOTICEABLE PERFORMANCE

10x

More contact than
conventional 12-point designs

1.7x

More contact than 2nd gen.
AS954 12-point

LIBRARY

SOCKETS, RATCHETS & ATTACHMENTS

WRIGHT SOCKETS FEATURE THE PATENTED

WRIGHT DRIVE®, WHICH PROVIDES MORE

TORQUE WITH LESS FASTENER DAMAGE.

WRIGHT'S WIDE RANGE OF RATCHETS

MEET YOUR EVERY NEED: DOUBLE-PAWL

RATCHETS IN 3/8" AND 1/2" DRIVES

PROVIDE RUGGEDNESS, EXTRA STRENGTH,

DURABILITY AND FINE TOOTH ACTION.

WE ALSO HAVE THE HANDLES AND

ATTACHMENTS YOU'RE LOOKING FOR-

FROM EXTENSIONS AND SPINNERS TO

UNIVERSALS AND FLEX HANDLES.



SOCKET, PRACTICES & ATTACHMENTS



1/4" DRIVE SOCKET SETS, RATCHETS & ATTACHMENTS



200

DRIVE SOCKET SETS

PART NUMBER	DESCRIPTION	UDM	NUMBER OF PIECES	SIZES INCLUDED	FINISH
200	1/4" Drive, 10 Piece 6 Point	SAE	10 Pieces	5/32"-1/2"	Chrome
209	1/4" Drive, 10 Piece 12 Point	SAE	10 Pieces	3/16"-9/16"	Chrome
256	1/4" Drive, 11 Piece 6 Point	Metric	11 Pieces	4mm - 14mm	Chrome
257	1/4" Drive, 9 Piece 6 Point	Metric	9 Pieces	5mm - 13mm	Chrome



2426

DRIVE RATCHETS

PART NUMBER	DESCRIPTION
2426	Ratchet—45 Teeth, 4-3/4"—Single Pawl, Swing Arc 3/4"
2492	Heavy-duty Ratchet—45 Teeth, 5-1/4", Contour Handle [Head Diameter only 1-5/64". Swing Arc 1"]



2492



2435

FLEX HANDLES

PART NUMBER	DESCRIPTION
2435	Flex Handle—5"



2404



2475

EXTENSIONS & UNIVERSAL

PART NUMBER	DESCRIPTION
2404	4" Extension
2406	6" Extension
2410	10" Extension
2414	14" Extension
2475	Universal 1-5/16" long



ADAPTORS

PART NUMBER	DESCRIPTION	LENGTH
2453	1/4" F x 3/8" M	1"



3/8" DRIVE SOCKET SETS



300

DRIVE SOCKET SETS

PART NUMBER	DESCRIPTION	UOM	NUMBER OF PIECES	SIZES INCLUDED	FINISH
300	3/8" Drive, 9 Piece 12 Point Deep Socket Set	SAE	9 Pieces	3/8" - 7/8"	Chrome
304	3/8" Drive, 9 Piece 6 Point Deep Socket Set	SAE	9 Pieces	3/8" - 7/8"	Chrome
312	3/8" Drive, 11 Piece 6 Point Standard Socket Set	SAE	11 Pieces	1/4" - 7/8"	Chrome
349	3/8" Drive, 12 Piece 12 Point Metric Standard Socket Set	Metric	12 Pieces	8mm - 19mm	Chrome
354	3/8" Drive, 14 Piece Metric Socket Set	Metric	14 Pieces	6mm - 19mm	Chrome
355	3/8" Drive, 14 Piece Deep Metric Socket Set	Metric	14 Pieces	6mm - 19mm	Chrome
378	3/8" Drive, 10 Piece 12 Point Standard Socket Set	SAE	10 Pieces	5/16" - 7/8"	Chrome



313

DRIVE 6 POINT IMPACT SOCKET SETS

PART NUMBER	DESCRIPTION	UOM	NUMBER OF PIECES	SIZES INCLUDED	STYLE	FINISH
313	3/8" Drive, 8 Piece Impact Socket Set	SAE	8 Pieces	5/16" - 3/4"	Standard	Black Oxide
314	3/8" Drive, 8 Piece Deep Impact Socket Set	SAE	8 Pieces	5/16" - 3/4"	Deep	Black Oxide
356	3/8" Drive, 12 Piece Impact Metric Socket Set 6 Point Standard	Metric	12 Pieces	8mm - 19mm	Standard	Black Oxide
357	3/8" Drive, 12 Piece Impact Metric Socket Set 6 Point Deep	Metric	12 Pieces	8mm - 19mm	Deep	Black Oxide
358	3/8" Drive, 14 Piece Impact Metric Socket Set 6 Point Deep	Metric	14 Pieces	6mm - 19mm	Deep	Black Oxide
359	3/8" Drive, 14 Piece Impact Metric Socket Set 6 Point Standard	Metric	14 Pieces	6mm - 19mm	Standard	Black Oxide

3/8" DRIVE RATCHETS & ATTACHMENTS



3425



3426



3440



3482

DRIVE RATCHETS

PART NUMBER	DESCRIPTION	OVERALL LENGTH	SWING ARC	NUMBER OF HEAD TEETH	RENEWAL KIT DIAMETER	RENEWAL KIT NUMBER
3425	Long Contour Handle-Double Pawl	10"	1-3/4"	41	1-1/4"	3491
3426	Knurled Grip-Double Pawl	7"	1-1/4"	41	1-1/4"	3491
3440	Compact-Palm Size Flex Head for Low Torque Application-Single Pawl	5-1/2"	1"	45	27/32"	3432
3482	Pear-Shaped Open Head Combination 3/8" and 1/4" Drives [crew chief ratchet]	7-7/8"	2-1/4"	30	1-1/8"	3483



3435

FLEX HANDLES

PART NUMBER	OVERALL DESCRIPTION	LENGTH
3435	Knurled Steel Handle	8-15/32"



EXTENSIONS & UNIVERSAL

PART NUMBER	OVERALL DESCRIPTION
3405	6" Extension
3408	8" Extension
3412	12" Extension
3475	Universal



3452



3454

ADAPTORS

PART NUMBER	DESCRIPTION	LENGTH
3452	3/8" F x 1/4" M	1-1/16"
3454	3/8" F x 1/2" M	1-3/8"



IMPACT ADAPTOR

PART NUMBER	DESCRIPTION	LENGTH
3899	3/8" F x 1/2" M	1-3/8"



IMPACT EXTENSION

PART NUMBER	DESCRIPTION
3903	3" Impact Extension
3906	6" Impact Extension
3908	12" Impact Extension



1/2" DRIVE SOCKETS



IMPACT 6 POINT / 12 POINT STANDARD SOCKETS

PART NUMBER	NOM. SIZE	SHAPE	L	DS	DD	BD
6 POINT SOCKET						
4812	3/8"	I	1-1/2"	21/32"	15/16"	5/32"
4814	7/16"	I	1-1/2"	23/32"	15/16"	7/32"
4816	1/2"	I	1-1/2"	51/64"	15/16"	7/64"
4818	9/16"	I	1-1/2"	57/61"	-	21/64"
4820	5/8"	II	1-1/2"	1"	1"	21/64"
4822	11/16"	II	1-1/2"	1-5/64"	1-5/64"	49/64"
4824	3/4"	II	1-1/2"	1-5/32"	1-5/32"	25/32"
4826	13/16"	II	1-9/16"	1-15/64"	1-15/64"	53/64"
4828	7/8"	II	1-5/8"	1-5/16"	1-5/16"	55/64"
4830	15/16"	II	1-11/16"	1-25/64"	1-25/64"	29/32"
4832	1"	II	1-23/32"	1-15/32"	1-15/32"	59/64"
4834	1-1/16"	III	1-3/4"	1-9/16"	1-3/8"	29/32"
4836	1-1/8"	III	1-13/16"	1-41/64"	1-3/8"	15/16"
4838	1-3/16"	III	1-7/8"	1-47/64"	1-3/8"	63/64"
4840	1-1/4"	III	1-15/16"	1-53/64"	1-3/8"	1-1/32"
4842	1-5/16"	III	2"	2"	1-3/8"	1-1/32"
4844	1-3/8"	III	2-1/16"	2-1/16"	1-17/32"	1-1/8"
4846	1-7/16"	III	2-5/32"	2-5/32"	1-17/32"	1-5/32"
4848	1-1/2"	III	2-3/16"	2-15/64"	1-17/32"	1-3/16"
12 POINT SOCKET						
4864	7/16"	I	1-15/32"	47/64"	15/16"	7/32"
4866	1/2"	I	1-15/32"	13/16"	15/16"	17/64"
4868	9/16"	II	1-15/32"	15/16"	15/16"	21/64"
4870	5/8"	II	1-15/32"	1"	1"	3/8"
4872	11/16"	II	1-15/32"	1-1/16"	1-1/16"	49/64"
4874	3/4"	II	1-15/32"	1-5/32"	1-5/32"	3/4"
4876	13/16"	II	1-9/16"	1-15/64"	1-15/64"	53/64"
4878	7/8"	II	1-5/8"	1-5/16"	1-5/16"	55/64"
4880	15/16"	II	1-11/16"	1-25/64"	1-25/64"	29/32"
4882	1"	II	1-23/32"	1-7/16"	1-7/16"	59/64"
4884	1-1/16"	III	1-3/4"	1-1/2"	1-3/8"	29/32"
4886	1-1/8"	III	1-13/16"	1-5/8"	1-3/8"	15/16"
4888	1-3/16"	III	1-7/8"	1-11/16"	1-3/8"	63/64"
4890	1-1/4"	III	1-15/16"	1-3/4"	1-3/8"	1-1/32"
4892	1-5/16"	III	2"	2-1/64"	1-3/8"	1-1/16"
4894	1-3/8"	III	2-1/16"	2-1/16"	1-17/32"	1-1/8"
4896	1-7/16"	III	2-1/8"	2-5/32"	1-17/32"	1-5/32"
4898	1-1/2"	III	2-3/16"	2-15/64"	1-17/32"	1-3/16"

REFERENCE DIAGRAMS

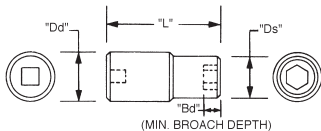

SHAPE I

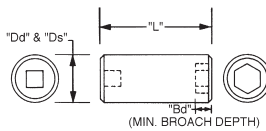

SHAPE II

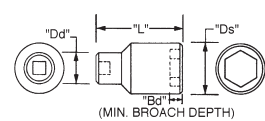

SHAPE III

1/2" DRIVE SOCKETS



IMPACT 6 POINT / 12 POINT DEEP SOCKETS

PART NUMBER	NOM. SIZE	SHAPE	L	DS	DD	BD
6 POINT SOCKET						
4912	3/8"	I	3-1/4"	21/32"	15/16"	5/32"
4914	7/16"	I	3-1/4"	23/32"	15/16"	7/32"
4916	1/2"	I	3-1/4"	51/64"	15/16"	17/64"
4918	9/16"	I	3-1/4"	7/8"	15/16"	21/64"
4920	5/8"	II	3-1/4"	1"	1"	3/8"
4922	11/16"	II	3-1/4"	1-1/16"	1-1/16"	2-35/64"
4924	3/4"	II	3-1/4"	1-5/32"	1-5/32"	2-17/32"
4926	13/16"	II	3-1/4"	1-15/64"	1-15/64"	2-1/2"
4928	7/8"	II	3-1/4"	1-5/16"	1-5/16"	2-3/4"
4930	15/16"	II	3-1/4"	1-3/8"	1-3/8"	2-27/32"
4932	1"	II	3-1/2"	1-7/16"	1-7/16"	2-45/64"
4934	1-1/16"	III	3-1/2"	1-1/2"	1-3/8"	2-21/32"
4936	1-1/8"	III	3-1/2"	1-5/8"	1-3/8"	2-5/8"
4938	1-3/16"	III	3-1/2"	1-3/4"	1-3/8"	2-19/32"
4940	1-1/4"	III	3-1/2"	1-3/4"	1-3/8"	2-19/32"
4942	1-5/16"	III	3-5/8"	2-1/64"	1-3/8"	2-9/16"
4944	1-3/8"	III	3-5/8"	2-1/16"	1-17/32"	2-35/64"
4946	1-7/16"	III	3-5/8"	2-5/32"	1-17/32"	2-17/32"
4948	1-1/2"	III	3-5/8"	2-15/64"	1-17/32"	2-1/2"
12 POINT SOCKET						
4964	7/16"	I	3-1/4"	47/64"	15/16"	7/32"
4966	1/2"	I	3-1/4"	13/16"	15/16"	17/64"
4968	9/16"	II	3-1/4"	15/16"	15/16"	21/64"
4970	5/8"	II	3-1/4"	1"	1"	3/8"
4972	11/16"	II	3-1/4"	1-1/16"	1-1/16"	3/8"
4974	3/4"	II	3-1/4"	1-5/32"	1-5/32"	2-1/2"
4976	13/16"	II	3-1/4"	1-15/64"	1-15/64"	2-1/2"
4978	7/8"	II	3-1/4"	1-5/16"	1-5/16"	2-3/4"
4980	15/16"	II	3-1/4"	1-3/8"	1-3/8"	2-27/32"
4982	1"	II	3-1/2"	1-7/16"	1-7/16"	2-45/64"
4984	1-1/16"	III	3-1/2"	1-1/2"	1-3/8"	2-21/32"
4986	1-1/8"	III	3-1/2"	1-5/8"	1-3/8"	2-5/8"
4988	1-3/16"	III	3-1/2"	1-3/4"	1-3/8"	2-19/32"
4992	1-5/16"	III	3-5/8"	2-1/64"	1-3/8"	2-9/16"
4994	1-3/8"	III	3-5/8"	2-1/16"	1-17/32"	2-35/64"
4996	1-7/16"	III	3-5/8"	2-5/32"	1-17/32"	2-17/32"



12 POINT STANDARD SOCKETS

PART NUMBER	NOM. SIZE	SHAPE	L	DS	DD	BD
4112	3/8"	I	1-1/2"	39/64"	7/8"	5/32"
4114	7/16"	I	1-1/2"	43/64"	7/8"	7/32"
4116	1/2"	I	1-1/2"	47/64"	7/8"	17/64"
4118	9/16"	I	1-1/2"	13/16"	7/8"	21/64"
4119	19/32"	II	1-1/2"	55/64"	55/64"	23/64"
4120	5/8"	II	1-1/2"	7/8"	7/8"	3/8"
4121	21/32"	II	1-1/2"	15/16"	15/16"	3/8"
4122	11/16"	II	1-1/2"	63/64"	63/64"	49/64"
4124	3/4"	II	1-1/2"	1-1/16"	1-1/16"	3/4"
4125	25/32"	II	1-1/2"	1-7/64"	1-7/64"	49/64"
4126	13/16"	II	1-9/16"	1-1/8"	1-1/8"	13/16"
4128	7/8"	II	1-5/8"	1-3/16"	1-3/16"	55/64"
4129	29/32"	II	1-5/8"	1-7/32"	1-7/32"	27/32"
4130	15/16"	II	1-5/8"	1-9/32"	1-9/32"	27/32"
4131	31/32"	II	1-21/32"	1-19/64"	1-19/64"	55/64"
4132	1"	III	1-21/32"	1-23/64"	1-23/64"	27/32"
4134	1-1/16"	III	1-3/4"	1-7/16"	1-7/64"	29/32"
4136	1-1/8"	III	1-13/16"	1-1/2"	1-7/64"	15/16"
4138	1-3/16"	III	1-7/8"	1-19/32"	1-7/64"	63/64"
4140	1-1/4"	III	1-59/64"	1-21/32"	1-7/64"	1"
4142	1-5/16"	III	1-31/32"	1-13/16"	1-7/64"	1-1/64"
4144	1-3/8"	III	2"	1-7/8"	1-1/4"	1-3/64"
4146	1-7/16"	III	2-1/16"	1-61/64"	1-1/4"	1-3/32"
4148	1-1/2"	III	2-1/8"	2"	1-1/4"	1-1/8"



12 POINT DEEP SOCKETS

PART NUMBER	NOM. SIZE	SHAPE	L	DS	DD	BD
4612	3/8"	I	3-3/64"	39/64"	13/16"	37/64"
4614	7/16"	I	3-3/64"	11/16"	13/16"	23/32"
4616	1/2"	I	3-3/64"	47/64"	7/8"	17/64"
4618	9/16"	I	3-3/64"	13/16"	7/8"	21/64"
4620	5/8"	II	3-3/64"	7/8"	7/8"	3/8"
4622	11/16"	II	3-3/64"	63/64"	63/64"	2-1/8"
4624	3/4"	II	3-3/64"	1-1/16"	1-1/16"	2-1/8"
4626	13/16"	II	3-3/64"	1-1/8"	1-1/8"	2-1/8"
4628	7/8"	II	3-3/64"	1-3/16"	1-3/16"	2-1/8"
4630	15/16"	II	3-3/64"	1-9/32"	1-9/32"	2-1/8"
4632	1"	III	3-3/64"	1-23/64"	-	2-1/8"
4634	1-1/16"	III	3-3/64"	1-7/16"	1-7/64"	2-1/8"
4636	1-1/8"	III	3-3/64"	1-1/2"	1-7/64"	2-1/8"
4638	1-3/16"	III	3-3/64"	1-19/32"	1-7/64"	2-1/8"
4640	1-1/4"	III	3-3/64"	1-21/32"	1-7/64"	2-1/8"
4642	1-5/16"	III	3-3/64"	1-13/16"	1-7/64"	2-1/8"
4644	1-3/8"	III	3-3/64"	1-7/8"	1-1/4"	2-1/8"
4646	1-7/16"	III	3-3/64"	1-61/64"	1-1/4"	2-1/8"
4648	1-1/2"	III	3-3/64"	2-1/64"	1-1/4"	2-1/8"

1/2" DRIVE RATCHETS & ATTACHMENTS



4425



4426



4428



4480



4482



4488



4494

RATCHETS

PART NUMBER	DESCRIPTION	OVERALL LENGTH	SWING ARC	NUMBER OF TEETH	HEAD DIAMETER	RENEWAL KIT NUMBER
4425	Long Knurled Grip-Double Pawl	15"	2"	45	1-5/8"	4491
4426	Knurled Grip-Double Pawl	10-1/4"	1-1/4"	45	1-5/8"	4491
4428	Construction Spud Ratchet, Black, 1/2" Sq. Drive Heavy-duty Round Head-Double Pawl	15"	2"	45	1-5/8"	34491
4480	Open Head, Pear Shape-Single Pawl	10-1/2"	3-1/4"	30	1-5/16"	4481
4482	Pear Head, Contour Handle Scaffold Wrench, Soft Face Hammer head/special 7/8" socket-Single Pawl	10-1/2"	3-1/4"	30	1-5/16"	N/A
4488	WrightGrip® SB Scaffold Ratchet	10-1/2"	3-1/4"	30	1-5/16"	N/A
4494	Long Contour Grip-Double Pawl	15"	2"	45	1-5/8"	4491



4430



4434

FLEX HANDLES

PART NUMBER	DESCRIPTION	OVERALL LENGTH
4430	Flex Head Knurled Grip-Double Pawl	18"
4434	Knurled Steel Handle	24"
4435	Knurled Steel Handle	18"



EXTENSIONS & UNIVERSAL

PART NUMBER	OVERALL DESCRIPTION
4402	2" Extension
4405	5" Extension
4410	10" Extension
4420	20" Extension
4475	Universal



ADAPTORS

PART NUMBER	DESCRIPTION	LENGTH
4453	1/2" F x 3/8" M	1-1/2"



IMPACT EXTENSIONS & UNIVERSAL

PART NUMBER	DESCRIPTION	LENGTH
4903	2" Pin Lock	
4905	5" Ball Lock	
4909	10" Pin Lock	
4910	24" Ball Lock [1/2" F x 3/8" M] Special Applications	
4800	Universal [Pin Lock]	2-11/16"



4900



4902

IMPACT ADAPTORS

PART NUMBER	DESCRIPTION	LENGTH
4900	1/2" F x 3/8" M [Ball Lock]	1-1/2"
4902	1/2" F x 3/4" M [Ball Lock]	2"

3/4" DRIVE SOCKETS



12 POINT STANDARD SOCKETS

PART NUMBER	NOM. SIZE	SHAPE	L	DS	DD	BD
6124	3/4"	I	2"	1-15/64"	1-19/64"	1/2"
6126	13/16"	II	2"	1-19/64"	1-19/64"	1/2"
6128	7/8"	II	2"	1-3/8"	1-3/8"	1/2"
6130	15/16"	II	2"	1-13/32"	1-13/32"	35/64"
6132	1"	III	2-1/32"	1-15/32"	1-15/32"	1-1/32"
6134	1-1/16"	III	2-1/16"	1-9/16"	1-29/64"	1-3/64"
6136	1-1/8"	III	2-1/8"	1-43/64"	1-29/64"	1-5/64"
6138	1-3/16"	III	2-1/8"	1-23/32"	1-29/64"	1-1/16"
6140	1-1/4"	III	2-3/16"	1-27/32"	1-37/64"	1-7/64"
6142	1-5/16"	III	2-1/4"	1-29/32"	1-37/64"	1-5/32"
6144	1-3/8"	III	2-1/4"	1-29/32"	1-37/64"	1-1/8"
6146	1-7/16"	III	2-5/16"	2-1/16"	1-37/64"	1-11/64"
6148	1-1/2"	III	2-5/16"	2-3/32"	1-39/64"	1-5/32"
6150	1-9/16"	III	2-7/16"	2-3/32"	1-39/64"	1-1/4"
6152	1-5/8"	III	2-1/2"	2-7/32"	1-39/64"	1-19/64"
6154	1-11/16"	III	2-1/2"	2-5/16"	1-5/8"	1-9/32"
6156	1-3/4"	III	2-21/32"	2-25/64"	1-43/64"	1-13/32"
6158	1-13/16"	III	2-13/16"	2-1/2"	1-3/4"	1-35/64"
6160	1-7/8"	III	2-7/8"	2-19/32"	1-3/4"	1-37/64"
6164	2"	III	3"	2-11/16"	1-3/4"	1-11/16"
6166	2-1/16"	III	3-1/32"	2-47/64"	1-61/64"	1-45/64"
6168	2-1/8"	III	3-1/16"	2-55/64"	1-61/64"	1-23/32"
6170	2-3/16"	III	3-1/16"	2-55/64"	1-61/64"	1-11/16"
6172	2-1/4"	III	3-3/16"	3-1/32"	1-61/64"	1-51/64"
6176	2-3/8"	III	3-1/4"	3-1/32"	1-61/64"	2"



6 POINT DEEP SOCKETS

PART NUMBER	NOM. SIZE	SHAPE	L	DS	DD	BD
6524	3/4"	II	3-1/2"	1-15/64"	1-19/64"	1/2"
6526	13/16"	II	3-1/2"	1-19/64"	1-19/64"	1/2"
6528	7/8"	II	3-1/2"	1-3/8"	1-3/8"	17/32"
6530	15/16"	II	3-1/2"	1-27/64"	1-27/64"	9/16"
6532	1"	II	3-1/2"	1-15/32"	1-15/32"	19/32"
6534	1-1/16"	III	3-1/2"	1-37/64"	1-7/16"	2-1/2"
6536	1-1/8"	III	3-1/2"	1-21/32"	1-7/16"	2-31/64"
6538	1-3/16"	III	3-1/2"	1-23/32"	1-32/64"	2-15/32"
6540	1-1/4"	III	3-1/2"	1-55/64"	1-1/2"	2-7/16"
6542	1-5/16"	III	3-1/2"	1-29/32"	1-9/16"	2-27/64"
6544	1-3/8"	III	3-1/2"	1-29/32"	1-9/16"	2-13/32"
6546	1-7/16"	III	3-1/2"	2-1/16"	1-43/64"	2-3/8"
6548	1-1/2"	III	3-1/2"	2-3/32"	1-43/64"	2-23/64"
6552	1-5/8"	III	3-1/2"	2-7/32"	1-39/64"	2-5/16"



IMPACT 6 POINT STANDARD SOCKETS

PART NUMBER	NOM. SIZE	RET RING	SHAPE	L	DS	DD	BD
6818	9/16"	6581	I	2-3/32"	1"	1-5/8"	21/64"
6820	5/8"	6581	I	2-3/32"	1-3/32"	1-5/8"	9/32"
6822	11/16"	6581	I	2-3/32"	1-5/32"	1-5/8"	5/16"
6824	3/4"	6581	I	2-3/32"	1-1/4"	1-5/8"	9/16"
6826	13/16"	6581	I	2-1/8"	1-3/8"	1-5/8"	39/64"
6828	7/8"	6581	I	2-1/8"	1-1/2"	1-5/8"	39/64"
6830	15/16"	6581	I	2-1/8"	1-9/16"	1-5/8"	19/32"
6832	1"	6581	II	2-1/8"	1-5/8"	1-5/8"	35/64"
6834	1-1/16"	6581	II	2-1/8"	1-11/16"	1-11/16"	1-7/64"
6836	1-1/8"	6582	II	2-1/8"	1-3/4"	1-3/4"	1-3/32"
6838	1-3/16"	6582A	II	2-1/8"	1-7/8"	1-7/8"	1-1/16"
6840	1-1/4"	6582A	II	2-1/8"	2"	2"	1-3/64"
6842	1-5/16"	6582A	II	2-1/8"	2-1/16"	2-1/16"	1-1/32"
6844	1-3/8"	6582A	III	2-1/4"	2-1/8"	1-29/32"	1-1/8"
6846	1-7/16"	6582A	III	2-1/4"	2-13/57"	1-29/32"	1-1/8"
6848	1-1/2"	6582A	III	2-1/2"	2-5/16"	1-29/32"	1-23/64"
6850	1-9/16"	6582A	III	2-1/2"	2-13/32"	1-29/32"	1-11/32"
6852	1-5/8"	6582A	III	2-1/2"	2-31/64"	1-29/32"	1-5/16"
6854	1-11/16"	6582A	III	2-5/8"	2-9/16"	1-29/32"	1-27/64"
6856	1-3/4"	6582A	III	2-5/8"	2-41/64"	1-29/32"	1-13/32"
6858	1-13/16"	6582A	III	2-5/8"	2-23/32"	1-29/32"	1-3/8"
6860	1-7/8"	6582A	III	2-3/4"	2-13/16"	1-29/32"	1-31/64"
6862	1-15/16"	6582A	III	2-3/4"	2-57/64"	1-29/32"	1-15/32"
6864	2"	6582A	III	2-7/8"	2-31/32"	1-29/32"	1-9/16"

3/4" DRIVE SOCKETS, RATCHETS & ATTACHMENTS



IMPACT 6 POINT DEEP SOCKETS

PART NUMBER	NOM. SIZE	RET RING	SHAPE	L	DS	OD	BD
6918	9/16"	6581	I	3-7/64"	1"	1-5/8"	21/64"
6920	5/8"	6581	I	3-7/64"	1-7/64"	1-5/8"	3/8"
6922	11/16"	6581	I	3-7/64"	1-11/64"	1-5/8"	3/8"
6924	3/4"	6581	I	3-7/64"	1-1/4"	1-5/8"	9/16"
6926	13/16"	6581	I	3-7/64"	1-3/8"	1-5/8"	39/64"
6928	7/8"	6581	I	3-7/64"	1-1/2"	1-5/8"	39/64"
6930	15/16"	6581	I	3-7/64"	1-9/16"	1-5/8"	19/32"
6932	1"	6581	II	3-7/64"	1-5/8"	1-5/8"	35/64"
6934	1-1/16"	6582	II	3-1/2"	1-11/16"	1-11/16"	2-31/64"
6936	1-1/8"	6582A	II	3-1/2"	1-3/4"	1-3/4"	2-15/32"
6938	1-3/16"	6582A	II	3-1/2"	1-27/32"	1-27/32"	2-7/16"
6940	1-1/4"	6582A	II	3-1/2"	1-59/64"	1-59/64"	2-27/64"
6942	1-5/16"	6582A	II	3-1/2"	2"	2"	2-1/2"
6944	1-3/8"	6582A	II	3-1/2"	2-1/16"	1-29/32"	2-13/32"
6946	1-7/16"	6582A	III	3-1/2"	2-5/32"	1-29/32"	2-3/8"
6948	1-1/2"	6582A	III	3-1/2"	2-15/64"	1-29/32"	2-23/64"
6950	1-9/16"	6582A	III	3-1/2"	2-5/16"	1-29/32"	2-11/32"
6952	1-5/8"	6582A	III	3-1/2"	2-13/32"	1-29/32"	2-5/16"
6954	1-11/16"	6582A	III	3-1/2"	2-31/64"	1-29/32"	2-19/64"
6956	1-3/4"	6582A	III	3-1/2"	2-9/16"	1-29/32"	2-9/32"
6958	1-13/16"	6582A	III	3-1/2"	2-41/64"	1-29/32"	2-1/4"
6960	1-7/8"	6582A	III	3-1/2"	2-23/32"	1-29/32"	2-15/64"
6962	1-15/16"	6582A	III	3-1/2"	2-13/16"	1-29/32"	2-7/32"
6964	2"	6582A	III	3-1/2"	2-57/64"	1-29/32"	2-25/64"
6966	2-1/16"	6582A	III	3-1/2"	2-31/32"	1-29/32"	2-7/16"
6968	2-1/8"	6582A	III	3-1/2"	3-3/64"	1-29/32"	2-7/16"



6400

RATCHETS

PART NUMBER	DESCRIPTION	OVERALL LENGTH
6400	Ratchet 3/4" DR	24"
6425	Ratchet RR Track 3/4" DR	42"



6435

FLEX HANDLES

PART NUMBER	DESCRIPTION	OVERALL LENGTH
6435	Knurled Steel Handle	23"



EXTENSIONS & UNIVERSAL

PART NUMBER	DESCRIPTION
6403	3-1/2" Extension
6408	8" Extension
6416	16" Extension
6475	3-13/16" Universal



ADAPTORS

PART NUMBER	DESCRIPTION	LENGTH
6450	3/4" F x 1/2" M	2-1/8"



IMPACT EXTENSIONS & UNIVERSAL

PART NUMBER	DESCRIPTION	OVERALL	
		RET RING LENGTH	OD
6907	7" Impact Extensions (with Pin Hole)	6581	
6910	10" Impact Extensions (with Pin Hole)	6581	
6913	13" Impact Extensions (with Pin Hole)	6581	
6800	Universal	6581	3-1/2" 1-7/8"



6900



6901

IMPACT ADAPTORS

PART NUMBER	DESCRIPTION	RET RING	LENGTH
6900	3/4" F x 1/2" M	6580	2-1/8"
6901	3/4" F x 1" M	6581	2-1/2"

1" DRIVE SOCKETS



12 POINT STANDARD SOCKETS

PART NUMBER	NOM. SIZE	SHAPE	L	DS	DD	BD
8134	1-1/16"	II	2-9/32"	1-41/64"	1-41/64"	5/8"
8136	1-1/8"	II	2-9/32"	1-11/16"	1-11/16"	21/32"
8138	1-3/16"	II	2-9/32"	1-49/64"	1-49/64"	21/32"
8140	1-1/4"	II	2-9/32"	1-53/64"	1-53/64"	3/4"
8142	1-5/16"	II	2-11/32"	1-57/64"	1-57/64"	49/64"
8144	1-3/8"	III	2-7/16"	1-61/64"	1-3/4"	25/32"
8146	1-7/16"	III	2-1/2"	2"	1-3/4"	7/8"
8148	1-1/2"	III	2-9/16"	2-9/64"	1-3/4"	55/64"
8150	1-9/16"	III	2-5/8"	2-13/64"	1-3/4"	1"
8152	1-5/8"	III	2-11/16"	2-1/4"	1-3/4"	1"
8154	1-11/16"	III	2-3/4"	2-25/64"	1-15/16"	1"
8156	1-3/4"	III	2-13/16"	2-33/64"	1-15/16"	1-3/32"
8158	1-13/16"	III	2-7/8"	2-37/64"	1-15/16"	1-1/8"
8160	1-7/8"	III	2-15/16"	2-41/64"	2-1/4"	1-1/8"
8162	1-15/16"	III	3"	2-3/4"	2-1/4"	1-7/32"
8164	2"	III	3"	2-3/4"	2-1/4"	1-7/32"
8166	2-1/16"	III	3-1/16"	2-61/64"	2-1/4"	1-7/32"
8168	2-1/8"	III	3-1/16"	2-61/64"	2-1/4"	1-3/8"
8170	2-3/16"	III	3-9/32"	3"	2-1/4"	1-3/8"
8172	2-1/4"	III	3-9/32"	3-5/64"	2-1/4"	1-3/8"
8174	2-5/16"	III	3-9/32"	3-11/64"	2-1/4"	1-3/8"
8176	2-3/8"	III	3-5/16"	3-1/4"	2-1/4"	1-3/8"
8178	2-7/16"	III	3-3/8"	3-5/16"	2-1/4"	1-3/8"
8180	2-1/2"	III	3-7/16"	3-3/8"	2-1/4"	1-3/8"
8182	2-9/16"	III	3-1/2"	3-3/8"	2-1/4"	1-1/2"
8184	2-5/8"	III	3-9/16"	3-9/16"	2-1/4"	1-3/4"
8188	2-3/4"	III	3-13/16"	3-23/32"	2-43/64"	1-3/4"
8190	2-13/16"	III	3-13/16"	3-27/32"	2-43/64"	1-3/4"
8194	2-15/16"	III	3-7/8"	3-31/32"	2-43/64"	2"
8196	3"	III	4-3/16"	4-1/32"	2-43/64"	2"
8197	3-1/8"	III	4-3/16"	4-3/16"	2-43/64"	2-13/64"
8198	3-3/8"	III	4-1/2"	4-35/64"	2-43/64"	2-13/64"
8199	3-1/2"	III	4-1/2"	4-35/64"	2-43/64"	2-13/64"



IMPACT 6 POINT DEEP SOCKETS

PART NUMBER	NOM. SIZE	RET RING	SHAPE	L	DS	DD	BD
8924	3/4"	6583	I	4"	1-7/16"	2"	7/16"
8926	13/16"	6583	I	4"	1-7/16"	2"	29/64"
8928	7/8"	6583	I	4"	1-17/32"	2"	1/2"
8930	15/16"	6583	I	4"	1-9/16"	2"	1/2"
8932	1"	6583	I	4"	1-21/32"	2"	35/64"
8933	1-1/16"	6583	I	4"	1-3/4"	2"	5/8"
8936	1-1/8"	6583	I	4"	1-13/16"	2"	21/32"
8938	1-3/16"	6583	I	4"	1-31/32"	2-1/16"	21/32"
8939	1-1/4"	6583	II	4"	2-1/16"	2-1/16"	3/4"
8942	1-5/16"	6583	II	4"	2-1/16"	2-1/16"	49/64"
8944	1-3/8"	6581A	III	4"	2-5/32"	2-1/8"	25/32"
8946	1-7/16"	6581A	III	4"	2-1/4"	2-1/8"	7/8"
8948	1-1/2"	6581A	III	4"	2-1/4"	12-1/8"	55/64"
8950	1-9/16"	6584	III	4"	2-1/2"	2-1/4"	55/64"
8952	1-5/8"	6584	III	4"	2-1/2"	2-1/4"	1"
8954	1-11/16"	6584	III	4"	2-1/2"	2-1/4"	1"
8956	1-3/4"	6585	III	4-1/16"	2-3/4"	2-7/16"	1-3/32"
8958	1-13/16"	6585	III	4-1/8"	2-3/4"	2-7/16"	1-1/8"
8960	1-7/8"	6585	III	4-3/16"	2-3/4"	2-7/16"	1-1/8"
8962	1-15/16"	6585	III	4-1/4"	2-63/64"	2-7/16"	1-1/8"
8964	2"	6585	III	4-5/16"	2-63/64"	2-7/16"	1-7/32"
8966	2-1/16"	6585	III	4-3/8"	2-63/64"	2-7/16"	1-7/32"
8968	2-1/8"	6585	III	4-7/16"	3-5/32"	2-7/16"	1-7/32"
8970	2-3/16"	6585	III	4-1/2"	3-1/4"	2-7/16"	1-3/8"
8972	2-1/4"	6585	III	4-21/32"	3-1/4"	2-7/16"	1-3/8"
8974	2-5/16"	6585	III	4-23/32"	3-13/32"	2-7/16"	1-3/8"
8976	2-3/8"	6585	III	4-3/4"	3-1/2"	2-7/16"	1-3/8"
8978	2-7/16"	6585	III	4-3/4"	3-17/32"	2-27/64"	1-3/8"
8980	2-1/2"	6585	III	4-7/8"	3-19/32"	2-7/16"	1-3/8"
8981	2-9/16"	6586	III	4-7/8"	3-23/32"	2-3/4"	1-3/8"
8984	2-5/8"	6586	III	4-7/8"	3-3/4"	2-3/4"	1-1/2"
8988	2-3/4"	6586	III	5"	3-53/64"	2-3/4"	1-3/4"
8990	2-13/16"	6586	III	5"	4"	2-3/4"	1-3/4"
8992	2-7/8"	6586	III	5"	4"	2-3/4"	1-3/4"
8994	2-15/16"	6586	III	5"	4"	2-3/4"	1-3/4"
8996	3"	6586	III	5"	4-3/16"	2-3/4"	2"
89100	3-1/8"	6586	III	5-1/2"	4-3/16"	2-3/4"	1-15/16"
89104	3-1/4"	6586	III	5-5/8"	4-17/32"	2-3/4"	2"
89108	3-3/8"	6586	III	5-3/4"	4-17/32"	2-3/4"	2"
89112	3-1/2"	6586	III	6"	4-3/4"	2-3/4"	2-13/64"
89116	3-5/8"	6587	III	6-1/8"	4-55/64"	3-1/4"	2-1/2"
89120	3-3/4"	6587	III	6-1/4"	5"	3-1/4"	2-1/2"
89124	3-7/8"	6587	III	6-3/8"	5-7/64"	3-1/4"	2-1/2"
89128	4"	6587	III	6-1/2"	5-1/4"	3-1/4"	2-1/2"
89132	4-1/8"	6587	III	6-3/4"	5-3/8"	3-1/4"	2-19/32"
89136	4-1/4"	6587	III	7"	5-17/32"	3-1/4"	2-3/4"
89144	4-1/2"	6587	III	7-1/4"	5-13/16"	3-1/4"	2-27/32"

1" DRIVE SOCKETS



IMPACT 6 POINT STANDARD SOCKETS

PART NUMBER	NOM. SIZE	RET RING	SHAPE	L	DS	DD	BD
8824	3/4"	6583	I	2-1/4"	1-7/16"	2"	7/16"
8826	13/16"	6583	I	2-1/4"	1-7/16"	2"	29/64"
8828	7/8"	6583	I	2-13/32"	1-17/32"	2"	1/2"
8830	15/16"	6583	I	2-7/16"	1-9/16"	2"	1/2"
8832	1"	6583	I	2-17/32"	1-21/32"	2"	35/64"
8834	1-1/16"	6583	I	2-9/16"	1-3/4"	2"	5/8"
8836	1-1/8"	6583	I	2-9/16"	1-13/16"	2"	21/32"
8838	1-3/16"	6583	I	2-11/16"	1-31/32"	2-1/16"	21/32"
8840	1-1/4"	6583	II	2-11/16"	2-1/16"	2-1/16"	3/4"
8842	1-5/16"	6583	II	2-11/16"	2-3/32"	2-3/32"	49/64"
8844	1-3/8"	6581A	III	2-11/16"	2-5/32"	2-7/64"	25/32"
8846	1-7/16"	6581A	III	2-11/16"	2-15/64"	2-7/64"	7/8"
8848	1-1/2"	6581A	III	2-11/16"	2-23/64"	2-7/64"	55/64"
8850	1-9/16"	6584	III	2-11/16"	2-31/64"	2-15/64"	55/64"
8852	1-5/8"	6584	III	2-11/16"	2-9/16"	2-15/64"	1"
8854	1-11/16"	6584	III	2-11/16"	2-39/64"	2-15/64"	1"
8856	1-3/4"	6585	III	2-11/16"	2-47/64"	2-27/64"	1-3/32"
8858	1-13/16"	6585	III	2-11/16"	2-25/32"	2-27/64"	1-1/8"
8860	1-7/8"	6585	III	2-13/16"	2-13/16"	2-27/64"	1-1/8"
8862	1-15/16"	6585	III	3"	2-29/32"	2-27/64"	1-1/8"
8864	2"	6585	III	3"	2-31/32"	2-27/64"	1-7/32"
8866	2-1/16"	6585	III	3"	3-1/16"	2-27/64"	1-7/32"
8868	2-1/8"	6585	III	3"	3-1/8"	2-27/64"	1-7/32"
8870	2-3/16"	6585	III	3-3/16"	3-15/64"	2-27/64"	1-3/8"
8872	2-1/4"	6585	III	3-3/16"	3-19/64"	2-27/64"	1-3/8"
8874	2-5/16"	6585	III	3-3/16"	3-25/64"	2-27/64"	1-3/8"
8876	2-3/8"	6585	III	3-1/4"	3-31/64"	2-27/64"	1-3/8"
8878	2-7/16"	6585	III	3-9/32"	3-17/32"	2-27/64"	1-3/8"
8880	2-1/2"	6585	III	3-5/16"	3-37/64"	2-27/64"	1-3/8"
8882	2-9/16"	6586	III	3-5/16"	3-23/32"	2-47/64"	1-3/8"
8884	2-5/8"	6586	III	3-15/32"	3-3/4"	2-47/64"	1-1/2"
8886	2-11/16"	6586	III	3-15/32"	3-53/64"	2-47/64"	1-1/2"
8888	2-3/4"	6586	III	3-9/16"	3-29/32"	2-47/64"	1-3/4"
8890	2-13/16"	6586	III	3-11/16"	4"	2-47/64"	1-3/4"
8892	2-7/8"	6586	III	3-3/4"	4-1/16"	2-47/64"	1-3/4"
8894	2-15/16"	6586	III	3-3/4"	4-1/8"	2-47/64"	1-3/4"
8896	3"	6586	III	3-7/8"	4-15/64"	2-47/64"	2"
8897	3-1/8"	6586	III	3-15/16"	4-11/32"	2-47/64"	1-15/16"
8898	3-3/8"	6586	III	4-3/16"	3-1/4"	3-1/4"	2"
8899	3-1/2"	6586	III	4-5/16"	3-1/4"	3-1/4"	2-13/64"
88116	3-5/8"	6587	III	4-3/4"	4-7/8"	3-1/4"	2-1/2"
88120	3-3/4"	6587	III	5"	4-63/64"	3-1/4"	2-1/2"
88124	3-7/8"	6587	III	5-1/4"	5-7/64"	3-1/4"	2-1/2"
88128	4"	6587	III	5-3/8"	5-1/4"	3-1/4"	2-1/2"
88132	4-1/8"	6587	III	5-3/8"	5-25/64"	3-1/4"	2-19/32"
88136	4-1/4"	6587	III	5-1/2"	5-17/32"	3-1/4"	2-3/4"
88144	4-1/2"	6587	III	5-5/8"	5-13/16"	3-1/4"	2-27/32"



1" DRIVE RATCHETS & ATTACHMENTS



8400

RATCHETS

PART NUMBER	DESCRIPTION	OVERALL LENGTH
8400	Ratchet 1" DR	30"
8425	Ratchet RR Track 1" DR	42"



FLEX HANDLE

PART NUMBER	DESCRIPTION
8435	26" Flex Handle



EXTENSIONS

PART NUMBER	DESCRIPTION
8408	8" Extension
8417	17" Extension



IMPACT EXTENSIONS & UNIVERSAL

PART NUMBER	DESCRIPTION	RET RING	OVERALL LENGTH	OD
8907	7" Impact Extension	6581A		
8910	10" Impact Extension	6581A		
8913	13" Impact Extension	6581A		
89E24	24" Impact Extension with Lock	6581A		
8800	Universal	6581A	4-1/2"	2-1/2"



8900



8902

IMPACT ADAPTORS

PART NUMBER	DESCRIPTION	RET RING	LENGTH
8900	1" F x 3/4" M	6583	2-3/4"
8902	1" F x 1-1/2" M	6584	3-1/2"

LIBRARY

WRENCHES

WRIGHT WRENCHES FEEL AS GOOD AS THEY LOOK. AND THEY HAVE A RESERVE OF STRENGTH FOR TOUGH JOBS. THEY FEATURE THE PATENTED WRIGHT DRIVE AND WRIGHT GRIP, WHICH PROVIDES MORE TORQUE WITH LESS FASTENER DAMAGE, DISTRIBUTING STRESS EVENLY OVER A LARGER CONTACT AREA AND AWAY FROM THE FASTENER CORNERS. THEY'RE IDEAL FOR APPLICATIONS RANGING FROM STANDARD NUTS AND BOLTS TO AEROSPACE FASTENERS. WE ALSO OFFER STRIKING WRENCHES FOR EXTRA-HEAVY-DUTY USE.



WRENCHES



WRENCH SETS



711

WRENCH SETS

PART NUMBER	DESCRIPTION	TYPE	NUMBER OF PIECES	SIZES INCLUDED	FINISH
711	11 Piece Combination Wrench Set 3/8" - 1" 12 Point	Combination Wrench Set	11 Pieces	3/8" - 1" 12 Point	Satin
714	14 Piece Combination Wrench Set 3/8" - 1-1/4" 12 Point	Combination Wrench Set	14 Pieces	3/8" - 1-1/4" 12 Point	Satin
715	15 Piece 12 Point Combination Wrench Set 5/16"-1- 1/4"	Combination Wrench Set	15 Pieces	5/16"-1-1/4" 12 Point	Satin
726	26 Piece 12 Point Comb. Wrench Set 1/4"-2"	Combination Wrench Set	26 Pieces	1/4"-2" 12 Point	Satin
730	16 Piece 12 Point Comb. Wrench Set 1-5/16" - 2-1/2"	Combination Wrench Set	16 Pieces	1-5/16" - 2-1/2" 12 Point	Satin
732	18 Piece Open End, Double Angle 15 & 60 Degrees	Double Angle Wrench Set	18 Pieces	11/32" - 1-1/2"	Chrome
738	8 Piece Open End Wrench Set 1/4" - 1-1/4"	Double Open End Wrench Set	8 Pieces	1/4" - 1-1/4"	Chrome
739	10 Piece Open End Wrenches 1/4" - 1-1/8"	Double Box Wrench Set	10 Pieces	1/4" - 1-1/8"	Chrome
749	7 Piece Box Wrenches 5/16" - 1-1/8"	Double Box Wrench Set	7 Pieces	5/16" - 1-1/8"	Chrome
760	28 Piece 12 Point Metric Combination Wrench Set, 6mm-50mm	Metric Combination Wrench Set	28 Pieces	6mm-50mm 12 Point	Satin
911	11 Pc Full Polish Combination Wrench Set 3/8" - 1" 12 Point	Combination Wrench Set	11 Pieces	3/8" - 1" 12 Point	Full Polish Chrome
914	14 Piece Full Polish Combination Wrench Set 3/8" - 1-1/4" 12 Point	Combination Wrench Set	14 Pieces	3/8" - 1-1/4" 12 Point	Full Polish Chrome
915	15 Piece Full Polish Combination Wrench Set 5/16" - 1-1/4" 12 Point	Combination Wrench Set	15 Pieces	5/16" - 1-1/4" 12 Point	Full Polish Chrome
950	11 Piece Full Polish Metric Combination Wrench Set 7mm-19mm 12 Point	Combination Wrench Set	11 Pieces	7mm-19mm 12 Point	Full Polish Chrome
952	15 Piece Full Polish Metric Combination Wrench Set, 7mm-22mm 12 Point	Combination Wrench Set	15 Pieces	7mm-22mm 12 Point	Full Polish Chrome
9429	5 Piece Ratcheting Box Wrench Set, Offset 1/4"-7/8"	Ratcheting Box Wrench Set	5 Pieces	1/4"-7/8"	Chrome



WRENCHES

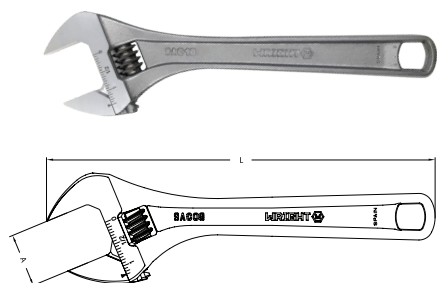

ADJUSTABLE WRENCHES

Chrome Finish

PART NUMBER	L-LENGTH	A-MAX. CAPACITY
9AC04 ¹	4"	1/2"
9AC06 ¹	6"	15/16"
9AC08 ¹	8"	1-3/16"
9AC10 ¹	10"	1-3/8"
9AC12 ¹	12"	1-1/2"
9AC15 ¹	15"	1-11/16"
9AC18 ¹	18"	2-1/8"
9AC24 ¹	24"	2-7/16"

Meets or exceeds ASME B107.100.
Made in Spain.

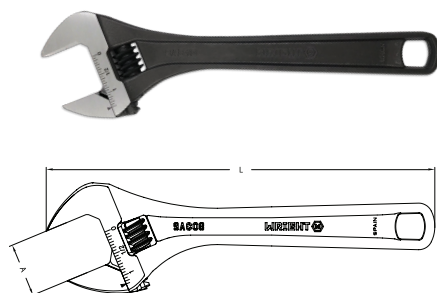

ADJUSTABLE WRENCHES

Black Industrial Finish

PART NUMBER	L-LENGTH	A-MAX. CAPACITY
9AB04	4"	1/2"
9AB06	6"	15/16"
9AB08	8"	1-3/16"
9AB10	10"	1-3/8"
9AB12	12"	1-1/2"
9AB15	15"	1-11/16"
9AB18	18"	2-1/8"
9AB24	24"	2-7/16"

Meets or exceeds ASME B107.100.
Made in Spain.

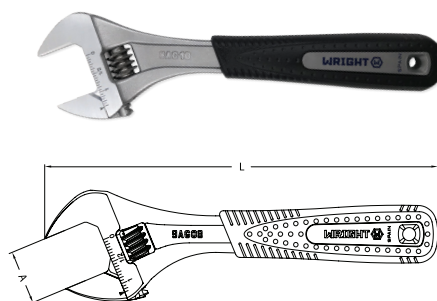

WRIGHT ULTIMATE GRIP ADJUSTABLE WRENCHES

PART NUMBER	L-LENGTH	A-MAX. CAPACITY
9AG04 ¹	4"	1/2"
9AG06 ¹	6"	15/16"
9AG08 ¹	8"	1-3/16"
9AG10 ¹	10"	1-3/8"
9AG12 ¹	12"	1-1/2"

Meets or exceeds ASME B107.100.
Made in Spain.

*Plastic dipped handle, not featured Wright Ultimate Grip handle



GIANT ADJUSTABLE WRENCH-36"

PART NUMBER	L-CAPACITY	HEAD THICKNESS	WEIGHT
9AC36	2-3/4"-4-3/4" (in 1/8" increments)	1-1/8"	31 lbs.

Meets or exceeds ASME B107.100.

WRENCHES

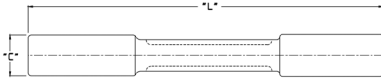
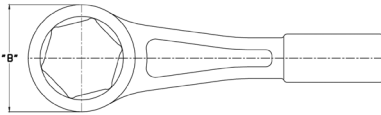

STRAIGHT HANDLE STRIKING FACE BOX WRENCHES 6 PT.

PART NUMBER	DESCRIPTION	NUT SIZE	STUD SIZE	FINISH
18H34	1-1/16" SAFETY ORANGE Straight Handle Striking Face Box Wrench	1-1/16"	5/8"	Safety Orange
18H40	1-1/4" SAFETY ORANGE Straight Handle Striking Face Box Wrench	1-1/4"	3/4"	Safety Orange
18H46	1-7/16" SAFETY ORANGE Straight Handle Striking Face Box Wrench	1-7/16"	7/8"	Safety Orange
18H52	1-5/8" SAFETY ORANGE Straight Handle Striking Face Box Wrench	1-5/8"	1"	Safety Orange
18H58	1-13/16" SAFETY ORANGE Straight Handle Striking Face Box Wrench	1-13/16"	1-1/8"	Safety Orange
18H64	2" SAFETY ORANGE Straight Handle Striking Face Box Wrench	2"	1-1/4"	Safety Orange
18H70	2-3/16" SAFETY ORANGE Straight Handle Striking Face Box Wrench	2-3/16"	1-3/8"	Safety Orange
18H76	2-3/8" SAFETY ORANGE Straight Handle Striking Face Box Wrench	2-3/8"	1-1/2"	Safety Orange
18H82	2-9/16" SAFETY ORANGE Straight Handle Striking Face Box Wrench	2-9/16"	1-5/8"	Safety Orange
18H88	2-3/4" SAFETY ORANGE Straight Handle Striking Face Box Wrench	2-3/4"	1-3/4"	Safety Orange
18H89	2-15/16" SAFETY ORANGE Straight Handle Striking Face Box Wrench	2-15/16"	1-7/8"	Safety Orange
18H90	3-1/8" SAFETY ORANGE Straight Handle Striking Face Box Wrench	3-1/8"	2"	Safety Orange
18H91	3-1/2" SAFETY ORANGE Straight Handle Striking Face Box Wrench	3-1/2"	2-1/4"	Safety Orange
18H92	3-7/8" SAFETY ORANGE Straight Handle Striking Face Box Wrench	3-7/8"	2-1/2"	Safety Orange

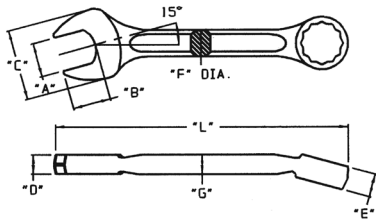

COMBINATION WRENCHES SATIN FINISH

WRIGHT GRIP^{2.0}



12 Point Heavy-duty Flat Stem

PART NUMBER	A	NOM. SIZE	L	C	B	D	E	F	G
1142	1-5/16"	19"	2-11/16"	1-15/32"	23/32"	7/8"	1"	3/4"	
1144	1-3/8"	20"	2-11/16"	1-17/32"	23/32"	7/8"	1"	3/4"	
1146	1-7/16"	21"	3"	1-19/32"	3/4"	15/16"	1-1/16"	7/8"	
1148	1-1/2"	22"	3"	1-21/32"	3/4"	15/16"	1-1/16"	7/8"	
1150	1-9/16"	23"	3-1/2"	1-15/16"	3/4"	15/16"	1-1/8"	7/8"	
1152	1-5/8"	23"	3-1/2"	1-15/16"	3/4"	15/16"	1-1/8"	7/8"	
1154	1-11/16"	23"	3-1/2"	1-15/16"	3/4"	15/16"	1-1/8"	7/8"	
1156	1-3/4"	25-1/2"	3-3/4"	2-1/16"	13/16"	1"	1-1/4"	1"	
1158	1-13/16"	25-1/2"	3-3/4"	2-3/32"	13/16"	1"	1-1/4"	1"	
1160	1-7/8"	28"	4-1/16"	2-3/16"	7/8"	1-1/16"	1-1/4"	1"	
1164	2"	28"	4-1/16"	2-5/16"	7/8"	1-1/16"	1-1/4"	1"	
1166	2-1/16"	28-1/4"	4-1/4"	2-11/16"	59/64"	1-7/32"	1-1/4"	1"	
1168	2-1/8"	28-1/4"	4-1/4"	2-25/64"	59/64"	1-7/32"	1-1/4"	1"	
1170	2-3/16"	28-3/4"	4-1/4"	2-27/64"	59/64"	1-7/32"	1-1/4"	1"	
1172	2-1/4"	29"	4-1/4"	2-29/64"	59/64"	1-7/32"	1-1/4"	1"	
1176	2-3/8"	29-1/4"	4-1/2"	2-15/32"	1"	1-9/16"	1-3/8"	1-1/8"	
1180	2-1/2"	29-1/2"	4-1/2"	2-1/2"	1"	1-9/16"	1-3/8"	1-1/8"	
1182	2-9/16"	29-3/4"	4-1/2"	2-1/2"	1"	1-9/16"	1-3/8"	1-1/8"	
1184	2-5/8"	29-3/4"	4-3/4"	2-5/8"	1-1/32"	1-5/8"	1-3/8"	1-1/8"	
1188	2-3/4"	29-3/4"	4-3/4"	2-3/4"	1-1/32"	1-5/8"	1-3/8"	1-1/8"	

Meets or exceeds ASME B107.100

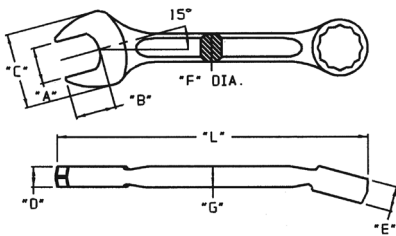

LARGE COMBINATION WRENCHES

PART NUMBER	NOM. SIZE	L	C	B	D	E	F	G
31166	2-1/16"	28-1/4"	4-1/4"	2-11/16"	59/64"	1-7/32"	1-1/4"	1"
31168	2-1/8"	28-1/2"	4-1/4"	2-25/64"	59/64"	1-7/32"	1-1/4"	1"
31170	2-3/16"	28-3/4"	4-1/4"	2-27/64"	59/64"	1-7/32"	1-1/4"	1"
31172	2-1/4"	29"	4-1/4"	2-29/64"	59/64"	1-7/32"	1-1/4"	1"
31176	2-3/8"	29-1/4"	4-1/2"	2-15/32"	1"	1-9/16"	1-3/8"	1-1/8"
31180	2-1/2"	29-1/2"	4-1/2"	2-1/2"	1"	1-9/16"	1-3/8"	1-1/8"
1190	2-13/16"	34"	5-3/4"	3"	1-3/8"	1-7/8"	1-1/2"	1-1/4"
1192	2-7/8"	34"	5-3/4"	3"	1-3/8"	1-7/8"	1-1/2"	1-1/4"
1194	2-15/16"	34"	5-3/4"	3"	1-3/8"	1-7/8"	1-1/2"	1-1/4"
1196	3"	34"	5-3/4"	3"	1-3/8"	1-7/8"	1-1/2"	1-1/4"
1198	3-1/16"	34"	5-3/4"	3"	1-3/8"	1-7/8"	1-1/2"	1-1/4"
11X00	3-1/8"	37"	6-3/16"	3-1/4"	1-3/8"	1-7/8"	1-3/4"	1-7/16"
11X04	3-1/4"	37"	6-3/16"	3-1/4"	1-3/8"	1-7/8"	1-3/4"	1-7/16"
11X08	3-3/8"	37"	6-3/16"	3-1/2"	1-3/8"	1-7/8"	1-3/4"	1-7/16"
11X12	3-1/2"	37"	6-3/16"	3-1/2"	1-3/8"	1-7/8"	1-3/4"	1-7/16"
11X16	3-5/8"	40"	7"	3-7/8"	1-5/8"	2"	1-7/8"	1-1/2"
11X20	3-3/4"	40"	7"	3-7/8"	1-5/8"	2"	1-7/8"	1-1/2"
11X24	3-7/8"	40"	7"	3-15/16"	1-5/8"	2"	1-7/8"	1-1/2"
11X28	4"	40"	7"	4"	1-5/8"	2"	1-7/8"	1-1/2"

WRENCHES



4477, 4478, 6448



8447



9S292

TORQUE WRENCHES & MULTIPLIERS

PART NUMBER	DESCRIPTION	TYPE	DRIVE SIZE	STYLE	TORQUE RANGE	HEAD STYLE	LENGTH
3477	Micro-Adjustable Torque Wrench, 20-100 Ft. Lbs.	Torque Wrench	3/8"	Click Type	20-100 ft. lbs.	Ratchet	15.5"
4477	Micro-Adjustable Torque Wrench, 30-150 Ft. Lbs.	Torque Wrench	1/2"	Click Type	30-150 ft. lbs	Ratchet	19"
4478	Micro-Adjustable Torque Wrench, 50-250 Ft. Lbs.	Torque Wrench	1/2"	Click Type	50-250 ft. lbs.	Ratchet	24"
6448	Click Type 3/4" Drive 120-600 Ft. Lbs.	Torque Wrench	3/4"	Click Type	120-600 ft. lbs.	Ratchet	41"
8447	Click Type 1" Drive 200-1000 Ft. Lbs., Ratchet Head	Torque Wrench	1"	Click Type	200-1000 ft. lbs.	Ratchet	70"
9S292	Torque Multiplier 3/4" Sq. F - 1" Sq. M Output Capacity 2,000 Ft. Lbs.	Torque Multiplier	3/4" Sq. Female - 1" Sq. Male	Torque Multiplier	571 ft lbs: 2000 ft lbs	n/a	19-1/2"

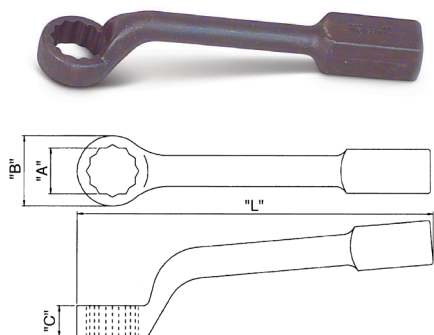

OFFSET STRIKING WRENCHES

PART NUMBER	DESCRIPTION	DEGREES OFFSET	STUD SIZE	SIZE
1932	1" Offset Handle Striking Face Box Wrench, 12 Point	45° Offset	12 point	1"
1934	1-1/16" Offset Handle Striking Face Box Wrench, 12 Point	45° Offset	12 point	1-1/16"
1936	1-1/8" Offset Handle Striking Face Box Wrench, 12 Point	45° Offset	12 point	1-1/8"
1938	1-3/16" Offset Handle Striking Face Box Wrench, 12 Point	45° Offset	12 point	1-3/16"
1940	1-1/4" Offset Handle Striking Face Box Wrench, 12 Point	45° Offset	12 point	1-1/4"
1942	1-5/16" Offset Handle Striking Face Box Wrench, 12 Point	45° Offset	12 point	1-5/16"
1946	1-7/16" Offset Handle Striking Face Box Wrench, 12 Point	45° Offset	12 point	1-7/16"
1948	1-1/2" Offset Handle Striking Face Box Wrench, 12 Point	45° Offset	12 point	1-1/2"
1952	1-5/8" Offset Handle Striking Face Box Wrench, 12 Point	45° Offset	12 point	1-5/8"
1954	1-11/16" Offset Handle Striking Face Box Wrench, 12 Point	45° Offset	12 point	1-11/16"
1956	1-3/4" Offset Handle Striking Face Box Wrench, 12 Point	45° Offset	12 point	1-3/4"
1958	1-13/16" Offset Handle Striking Face Box Wrench, 12 Point	45° Offset	12 point	1-13/16"
1960	1-7/8" Offset Handle Striking Face Box Wrench, 12 Point	45° Offset	12 point	1-7/8"
1962	1-15/16" Offset Handle Striking Face Box Wrench, 12 Point	45° Offset	12 point	1-15/16"
1964	2" Offset Handle Striking Face Box Wrench, 12 Point	45° Offset	12 point	2"

Note: Available up to size 4-1/4"

WRENCHES



STRIKE-FREE LEVERAGE WRENCH

PART NUMBER	NOM. SIZE	TUBE	LENGTH	LENGTH WITH TUBE HANDLE	A HEAD DIAMETER	B HEAD THICKNESS
19B32	1"	19A24	13"	33-1/2"	2-1/16"	7/8"
19B34	1-1/16"	19A24	13"	33-1/2"	2-1/16"	7/8"
19B36	1-1/8"	19A24	13"	33-1/2"	2-1/16"	7/8"
19B38	1-3/16"	19A24	13"	33-1/2"	2-1/16"	7/8"
19B40	1-1/4"	19A24	13"	33-1/2"	2-1/16"	7/8"
19B42	1-5/16"	19A24	13"	33-1/2"	2-1/16"	7/8"
19B44	1-3/8"	19A24	13"	33-1/2"	2-1/16"	7/8"
19B46	1-7/16"	19A24	13-1/2"	33"	2-13/16"	1-1/8"
19B48	1-1/2"	19A24	13-1/2"	33"	2-13/16"	1-1/8"
19B50	1-9/16"	19A24	13-1/2"	33"	2-13/16"	1-1/8"
19B52	1-5/8"	19A24	13-1/2"	33"	2-13/16"	1-1/8"
19B54	1-11/16"	19A36	13-1/2"	45"	2-13/16"	1-1/8"
19B56	1-3/4"	19A36	13-1/2"	45"	2-13/16"	1-1/8"
19B58	1-13/16"	19A36	13-1/2"	45"	2-13/16"	1-1/8"
19B60	1-7/8"	19A36	13-7/8"	45-1/2"	2-15/16"	1-1/8"
19B62	1-15/16"	19A36	13-7/8"	45-1/2"	2-15/16"	1-1/8"
19B64	2"	19A36	13-7/8"	45-1/2"	2-15/16"	1-1/8"



12

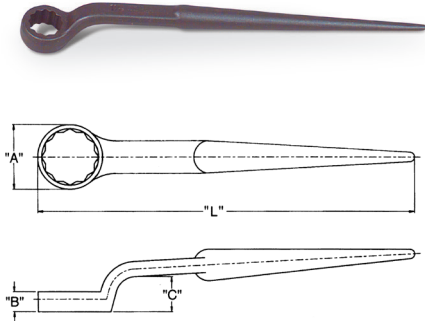

CONSTRUCTION—STRUCTURAL I2 PT. SPUD HANDLE BOX WRENCHES

Black Industrial Finish

PART NUMBER	NOM. SIZE	A	B	C	L
1756	13/16"	1-15/32"	11/16"	1-25/32"	12"
1758	7/8"	1-15/32"	11/16"	1-25/32"	12"
1760	15/16"	1-5/8"	13/16"	1-61/64"	12"
1762	1"	1-5/8"	13/16"	1-61/64"	12"
1764	1-1/16"	1-53/64"	7/8"	2-9/64"	15"
1766	1-1/8"	1-53/64"	7/8"	2-9/64"	15"
1770	1-1/4"	2-5/64"	15/16"	2-21/64"	17"
1772	1-5/16"	2-5/64"	15/16"	2-21/64"	17"
1776	1-7/16"	2-3/8"	1-1/8"	2-3/4"	21"
1778	1-1/2"	2-3/8"	1-1/8"	2-3/4"	21"
1782	1-5/8"	2-5/8"	1-3/16"	2-7/8"	22"
1784	1-11/16"	2-5/8"	1-3/16"	2-7/8"	22"
1788	1-13/16"	2-29/32"	1-1/4"	3"	23"
1790	1-7/8"	2-29/32"	1-1/4"	3"	23"
1794	2"	3-5/32"	1-3/8"	3-5/32"	24-1/2"
1795	2-3/16"	3-15/32"	1-1/2"	3-1/2"	26"
1796	2-3/8"	3-23/32"	1-5/8"	3-11/16"	28"
1797	2-9/16"	3-29/32"	1-3/4"	3-13/16"	30"
1798	2-3/4"	4-5/32"	1-7/8"	3-29/32"	30"

Some items may be special order.

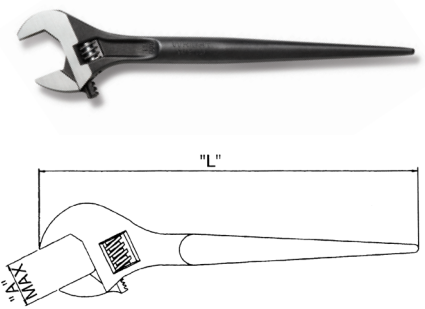

ADJUSTABLE CONSTRUCTION SPUD WRENCHES

Black Industrial Finish

PART NUMBER	MAX OPENING	L
9413	1-1/4"	10"
9414	1-1/2"	16"

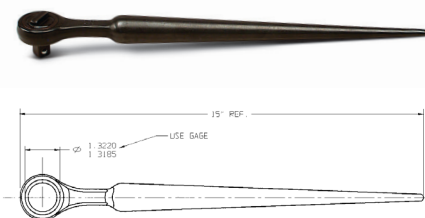

CONSTRUCTION SPUD RATCHET

Black Industrial Finish. Features 1/2" drive and a heavy-duty round head. Requires only 4° arc swing for tight spots.

PART NUMBER	L OVERALL LENGTH	NUMBER OF TEETH	A HEAD DIAMETER	RENEWAL KIT NUMBER
4428	15"	45	1-5/8"	34491

hacksaw | Number2 phillips screwdriver | ~~16' tape measure~~ | ~~10" tongue and groove pliers~~ | flexible scraper blade
| ~~bull nose pliers~~ | ~~feeler gauge~~ | 3/8" 12 Point combination wrench | soft face hammer | 24 piece master punch
& chisel kit | 7" duck bill needle nose | fractional l-key set | ~~12 Point deep socket set~~ | dominator carbon scraper
| 30 degree service wrench | ~~1/4" center punch~~ | ~~utility knife~~ | 10" pipe wrench | 7" impact extension | 3/8" drive
ratchet | 5/16" 12 Point combination wrench | ~~claw hammer~~ | 15 piece metric combination wrench set | 16" in
~~head pry bar~~ | 10" curved jaw locking pliers | magnetic pick-up tool | ~~ratcheting flare nut wrench set~~ | 1" extensio
| sliding t | 7" contour grip ratchet | ~~hex bit socket set~~ | 1/4" 12 Point combination wrench | 30 degree service
wrench | 12Point standard socket set | 24" pinch bar | ~~straight jaw locking pliers~~ | ~~3 1/2" linesmen's round nos~~
pliers | ~~1 lb. dead blow hammer~~ | Number3 phillips screwdriver | screw extractor set | 32 oz. ball peen hammer
| ~~1/2" drive speeder~~ | ~~adjustable torque wrench~~ | punch & chisel holder | lap joint pliers | mixture op
~~end wrench~~ | ~~9/16" standard socket~~ | 9/16" 12Point deep socket | ~~5" s~~ | ~~cur~~



PIC
YO
LE
ON

CK THE TOOLS

U NEED.

CUSTOM S-SETS FROM WRIGHT

- Convenience of pre-assembled sets
- Personalized set number for easy reordering
- Specialized for your job sites and crew

AVE OUT THE

IES YOU DON'T.



THE WRIGHT

**THERE'S ALWAYS
THE EASY WAY,
AND THEN
THERE'S THE
WRIGHT WAY.**

WAY

Since 1927, 'hard work' has been more than just a slogan and 'easy' just isn't part of our family vocabulary. Getting the job done is the truest test of any tool however, ensuring your safety is our company's purpose.

FOR MORE DETAILS ON
OUR SAFETY TRAINING PROGRAM
OR ANY OF OUR PRODUCTS
CONTACT YOUR REP OR EMAIL
SAFETY@WRIGHTTOOL.COM

THAT'S NOT
ALL WE HAVE
TO OFFER.

ASK TO SEE
OUR FULL
CATALOG.

Product questions,
call Customer Service:
1 800 321 2902

Locate a local or
international distributor:
wrighttool.com

Order now via email or fax:
orders@wrighttool.com
1 800 543 2095

YOU DON'T JUST HAND SOMEONE A WRIGHT TOOL, YOU PASS IT DOWN THE LINE.

That's because we craft every tool with pride to outlast you, and the next generation. Hot-forged from steel, you'll break before our tools do. That's why we back every product. To us, making tools that last will always come first.



PA D



MADE RIGHT. RIGHT HERE.



WRENCHES

RATCHETS

SOCKETS

ATTACHMENTS

To see our full-line catalog,
scan the QR Code.



WRIGHT 

ONE WRIGHT DRIVE, PO BOX 512
BARBERTON, OHIO 44203 USA

WRIGHTTOOL.COM

TOLL FREE 1 800 321 2902